

NEXPAND

NEXT LEVEL DATA CENTER SOLUTIONS



THE WORLDWIDE SPECIALIST IN SCALABLE AND
INTEGRATED DATA CENTER INFRASTRUCTURE SOLUTIONS

MINKELS
A brand of **legrand**

NEXPAND

NEXT LEVEL DATA CENTER SOLUTIONS



The digital revolution is happening right now. It's taking place both in our personal and business lives. The way we do our work, listen to music, interact with people, research products and buy services has almost entirely changed. And so have IT infrastructures to make this change possible. An ever-increasing amount of data, faster processing speeds, larger storage requirements, the exponential rise in IoT and artificial intelligence, and so forth have posed new challenges in data centers.

We've researched, analyzed, discussed, checked and rechecked ways we could optimize the data center infrastructure. Can it work smarter, better and more sustainably? How can we provide smart solutions to cope with the challenges in this market? Can we develop systems to help companies comply with various environmental requirements and compliancy laws? Can we act with greater corporate social responsibility across every aspect of our business?

OUR MISSION WITH THE DEVELOPMENT OF OUR NEW PLATFORM WAS TO CREATE SOMETHING THAT'S SMART, SOLID, SECURE & SUSTAINABLE.

WHAT WE PROMISE

A data center must accommodate IT infrastructure in the most efficient way possible. Infrastructure needs the space to grow and evolve with new circumstances, technology, and user requirements. Therefore, modifications and innovations are also necessary for next level data center cabinets to help ensure improved uptime, efficiency, security, and sustainability.

The Nexpand cabinet platform offers you the space to accommodate whatever comes next!

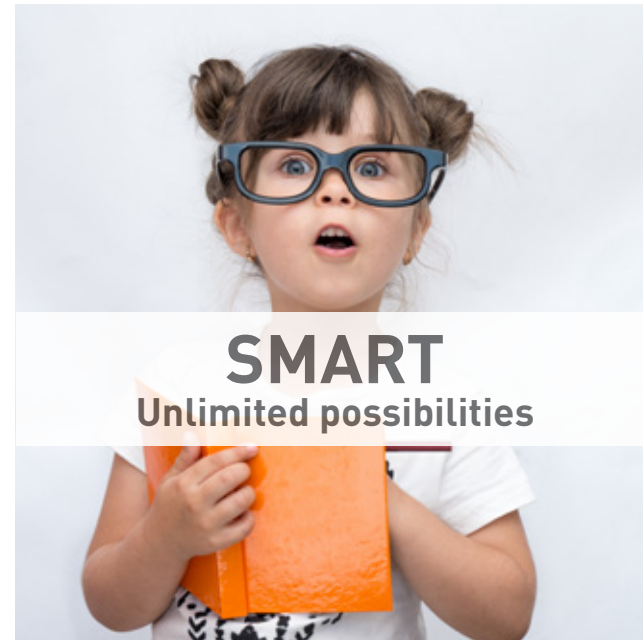

NEXPAND SMART

UNLIMITED POSSIBILITIES

A smart design was one of the main requirements by developing the Nexpan platform. With Nexpan we went the extra mile with the flexibility and modularity of the installation and infinite adjustment of accessories and components. It's truly the next level in data center infrastructure.

Nexpan is a huge leap forward for our customers. The design has been achieved by working closely with our customers for many years. During the design we constantly looked to expand possibilities and provide high levels of scalability. The functionality has been seamlessly integrated into the aluminium frame providing a fully integrated platform and the opportunity to be combined with systems and products from the Legrand portfolio.

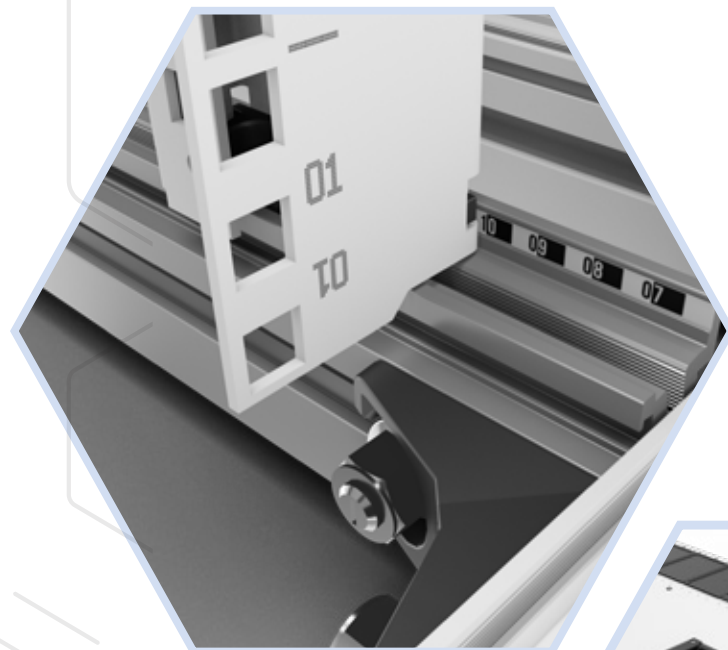

Stepless adjustability

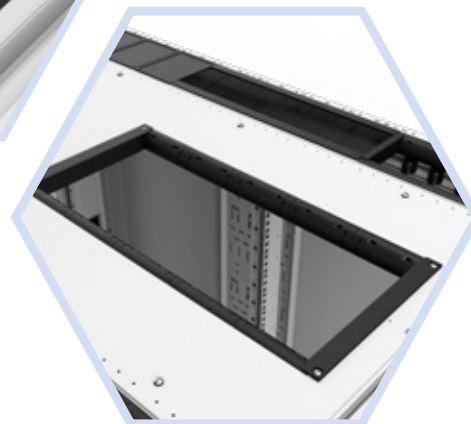

Modular roof

EFFICIENT, MODULAR EXTENSION

For the interior of the server cabinet, aluminium extrusions are used, in which mounting rails are installed that are adjustable in the full width and depth. All the accessories can be mounted flexibly across all three dimensions and infinitely adjusted. In that way, the interior of the server cabinet can be custom designed without being dependent on specific holes or modular dimensions of holes. These holes would also negatively impact air tightness.

EASY MAINTENANCE

Another unique property is the option to mount and remove all the accessories and components located in the cabinet from the inside. That means that – even if a cabinet is bayed or is closed – it is easy to change, remove or add practically everything from inside. System administrators or data center managers in particular can benefit tremendously from the flexibility that the interior offers. The interior makes cable management, adding components and making changes much easier.

INTEGRATION

Within the new cabinet it is easy to add intelligent locks, power distribution units and sensors which make it possible to remotely monitor your data center and cabinets. This enables users to stay in control (remotely) of the condition of the IT equipment and the environmental factors in the cabinet that relate to air humidity, temperature and air circulation.

Smart products from the Legrand portfolio can perfectly be integrated into our server and network cabinet platform. In this way, we deliver a total solution with which we can meet your every need.

SMART TOP-OF-CABINET DESIGN

The amount of cabling in cabinets has increased considerably. To be able to continue to meet the changing needs, we have developed a cabinet with a smart, optimized design. For example, the top-of-cabinet section contains more space to guide the cables through and the positioning of the entries is improved.

NEXPAND SOLID

NEXT LEVEL RELIABILITY

Nexpand's platform enables a solid structure to perfectly house your IT-equipment. The interior of our server and network cabinets has a light and solid aluminium frame to bear the weight of IT equipment and to deal

effectively with airflow management. The sturdiness of the frame and door, the full integration of the locking system and the cabling are unique on the market.



UNIQUE DOOR DESIGN

The full integration of the locking mechanism and cabling (in case of smart lock) are unique. The integration of these systems offers better protection for the cabling. Specifically, this prevents people working on the cabinet from bumping into the cabling and causing damage. It is also easier to mount and remove the door, which can be useful during work in the cabinet. The door can also be easily reversed to make the door right-opening rather than left-opening.

A solid double door is also part of the Nexpand platform, which can be very practical in case of limited space



LIGHT AND SOLID FRAME

The light and solid aluminium frame offers ultimate flexibility because mounting and T-slot rails are placed in aluminium extrusions. In that way, the interior of the cabinet can be perfectly adjusted to the user's requirements without being dependent on certain holes or modular dimensions of holes. It is therefore possible to install all the accessories that are intended for cabling or for holding IT equipment in exactly the spot where it can be used most effectively. It is important that the interior is easily adjustable – because not all the IT equipment that is placed in a cabinet is always delivered with the same standard dimensions.

Another unique property of the interior is the option to mount and remove all the accessories and components located in the cabinet from the inside. That means that – even if a cabinet is bayed or is closed – it is easy to change, remove or add practically everything from inside.

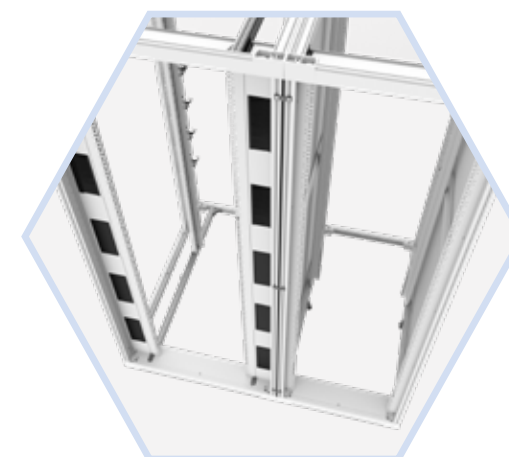

NEXPAND SECURE

KEEP YOUR DATA SAFE

The greatest risk of any data center is downtime. The new platform enables the highest levels of access security and reliable intelligent power distribution. Innovative

monitoring tools and sensors reliably work around the clock to detect and alert data center operators in case of sudden changes in and around the rack to prevent outages.

HIGH LEVEL ACCESS SECURITY

The design of our server and network cabinets offers the possibility to use not only standard mechanical locks (such as cylinder locks), but also smart locks. Smart locks can be opened remotely or enable the user to remotely monitor who was in the cabinet at what time. As an option you can use a camera system. Some locks also offer the possibility to grant someone access remotely – whether temporarily or otherwise – to the cabinet. These types of locks often entail the requisite cabling, which can be perfectly integrated into our door thanks to the duct which is integrated in the door. All the areas of the cabinets can also be locked from the inside using standard key locks to ensure that they cannot be opened from the outside. All these points ensure high level access security.



RELIABLE POWER DISTRIBUTION

Power is an operationally critical component of any data center. Even the slightest interruption of the power supply can have a huge impact. The new cabinet platform makes it possible to manage the risks of power outages by using basic and intelligent PDUs from the Legrand portfolio.

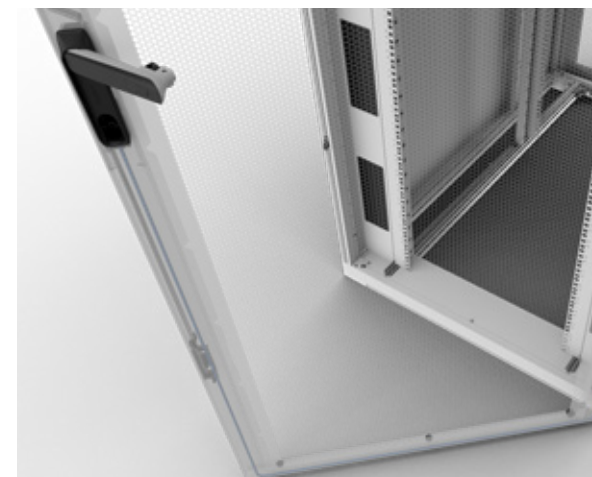
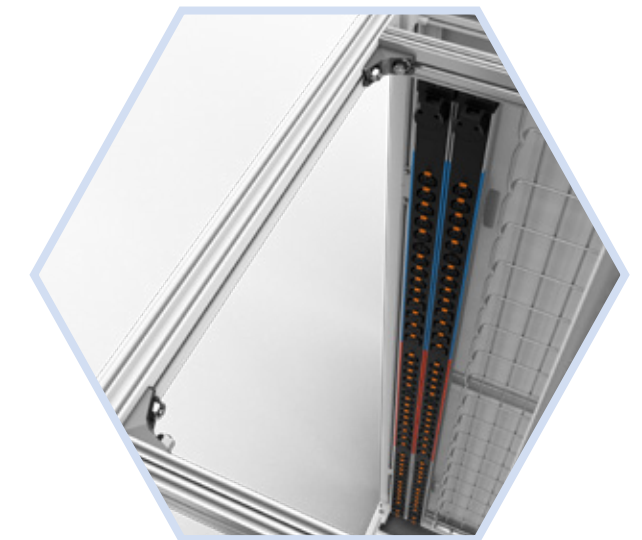

Full integration of the locking mechanism and cabling in case of smart locks.

NEXPAND SUSTAINABLE

NEXT LEVEL ENERGY EFFICIENCY

With server cabinets in particular, the requirements in the area of energy efficiency are high. After all, the IT equipment in server cabinets produces a great deal of heat that must be removed efficiently. Indeed, in order to function as effectively as possible, the IT equipment must be adequately cooled, because the more efficient the cooling process is, the more reliably the IT equipment works, and the less energy is required to enable the data center to run.

The design of our server and network cabinets is specifically geared towards optimizing the energy efficiency of data centers. Increasing the energy efficiency was one of the most important reasons for developing this cabinet platform. By reducing energy consumption, data centers can not only save on costs, but can also reduce the impact on the environment.

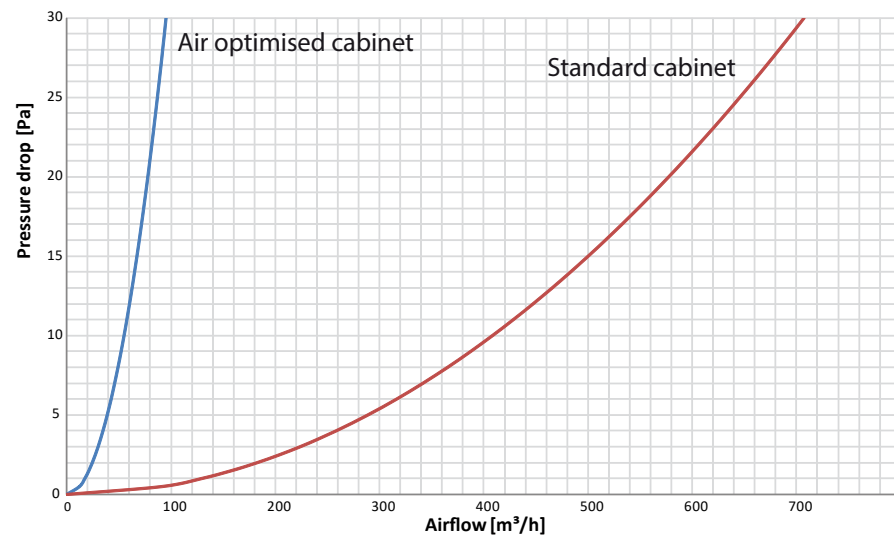

Efficiency comparison between a standard and an airflow optimised cabinet

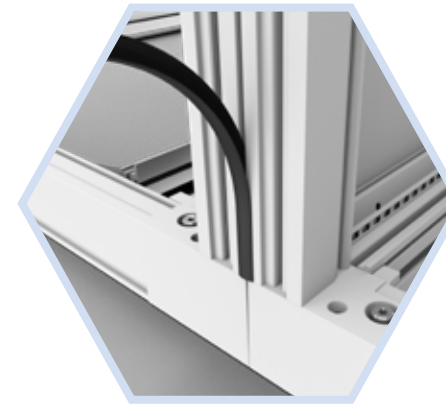

PREVENTING COOL AIR LEAKAGE

AIRTIGHTNESS AT VERTICAL MOUNTING RAIL PERIMETER

It is extremely important that air leakage and recirculation is minimized so that the cool air is guided exclusively through the IT equipment. To do this, the space between the frame of the cabinet and the steel profiles (in which the IT equipment is installed) must be perfectly sealed. In that way, the separation between the hot and cold airflows can be optimized. To do this, airflow management packages can be used that consist of a bottom, top, left and right plate. These plates connect the cabinet with the profiles in which the IT equipment is installed.

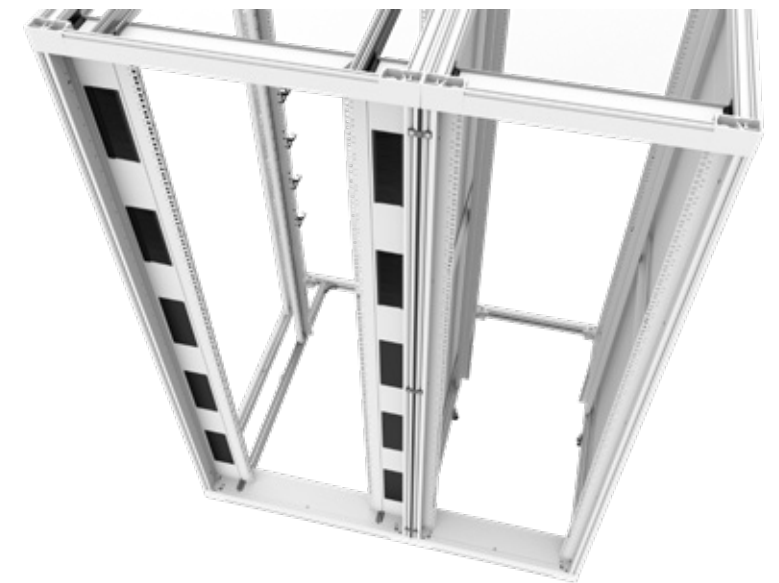

Airflow management for 600 mm and 800 mm wide cabinets

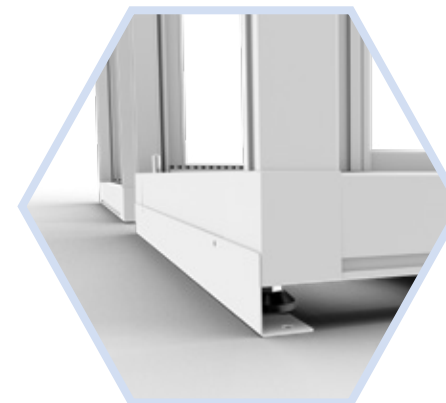

AIRTIGHTNESS AT CABINET PERIMETER

Special accessories have also been developed such as sealing strips. These strips are used to perfectly seal the spaces between the cabinets. If a cabinet is leveled or placed on castors the gap can be sealed with an airtight plinth.

NEXPAND SUSTAINABLE

NEXT LEVEL ENERGY EFFICIENCY

Once we had established the platform's functionality, we needed to establish the function of every component. We had a simple philosophy: if there is no clear added customer value, it isn't part of Nexpand! Every element plays a key role in the system's functionality and performance.

The server and network cabinets have been designed based on the following principles: Design for Manufacturability, Design for Assembly and Environmentally Oriented Development. **Design for Manufacturability** is

MANUFACTURING PROCESS

Our server and network cabinets have been specifically designed to help create data centers that are more environmentally friendly. The impact on the environment was also considered by using the most environmentally friendly materials possible in the manufacturing process of the cabinets and by avoiding the use of materials that are harmful to the environment. Additionally, several process steps are carried out internally rather than being outsourced, which contributes to a more environmentally friendly manufacturing process for the cabinets.

a methodology in which the emphasis is on the producibility of the design. **Design for Assembly** is a methodology for improving the 'producibility' of a product design. **Environmentally Oriented Development** is about being mindful of the impact that the development of a product has on the environment. We can demonstrate this with a Product Environmental Profile (check out: www.minkels.com/technical-datasheets/enclosures).

DESIGN

The design is geared towards a more efficient use of energy in data centers by ensuring that the heat-generating IT equipment can be cooled as efficiently as possible. The cabinets have been designed in such a way that they enable optimal airflow management. This is because, by using airflow management packages and a wide range of accessories, air leakage and recirculation, and in turn excessive changes in temperature, can be avoided. This optimizes the reliability of the IT equipment, and ensures that less energy is required to enable the data center to operate. This can lead to cost savings.



www.legrand.com/en/our-responsibility/csr-home



NEXPAND FEATURES

FRAME & DOOR

FRAME

- Light and solid aluminium frame with the capability to handle 1500 kg of static load.
- Offers unique flexibility through stepless mounting possibilities in all three dimensions of the cabinet.
- Threaded mounting rails in width, depth and height direction enable stepless adjustability (for example cable management).
- Integrated T-slots provide stepless adjustability in depth and width direction (for example vertical mounting rail adjustment).
- Nearly all accessories and components accessible from inside of the cabinet.
- The cabinet is ready for placement of slide-in-side panels. This feature provides separation of cabinets, even after the cabinets are already installed and bayed.
- Upgrade the energy efficiency by adding an airflow package in a later stage is possible.

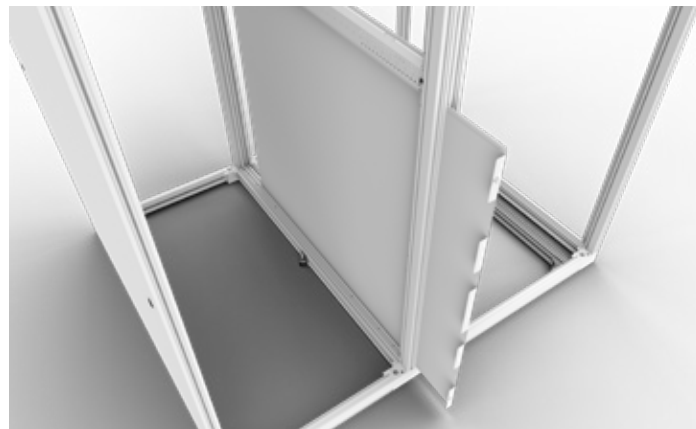

Slide-in side panel ready

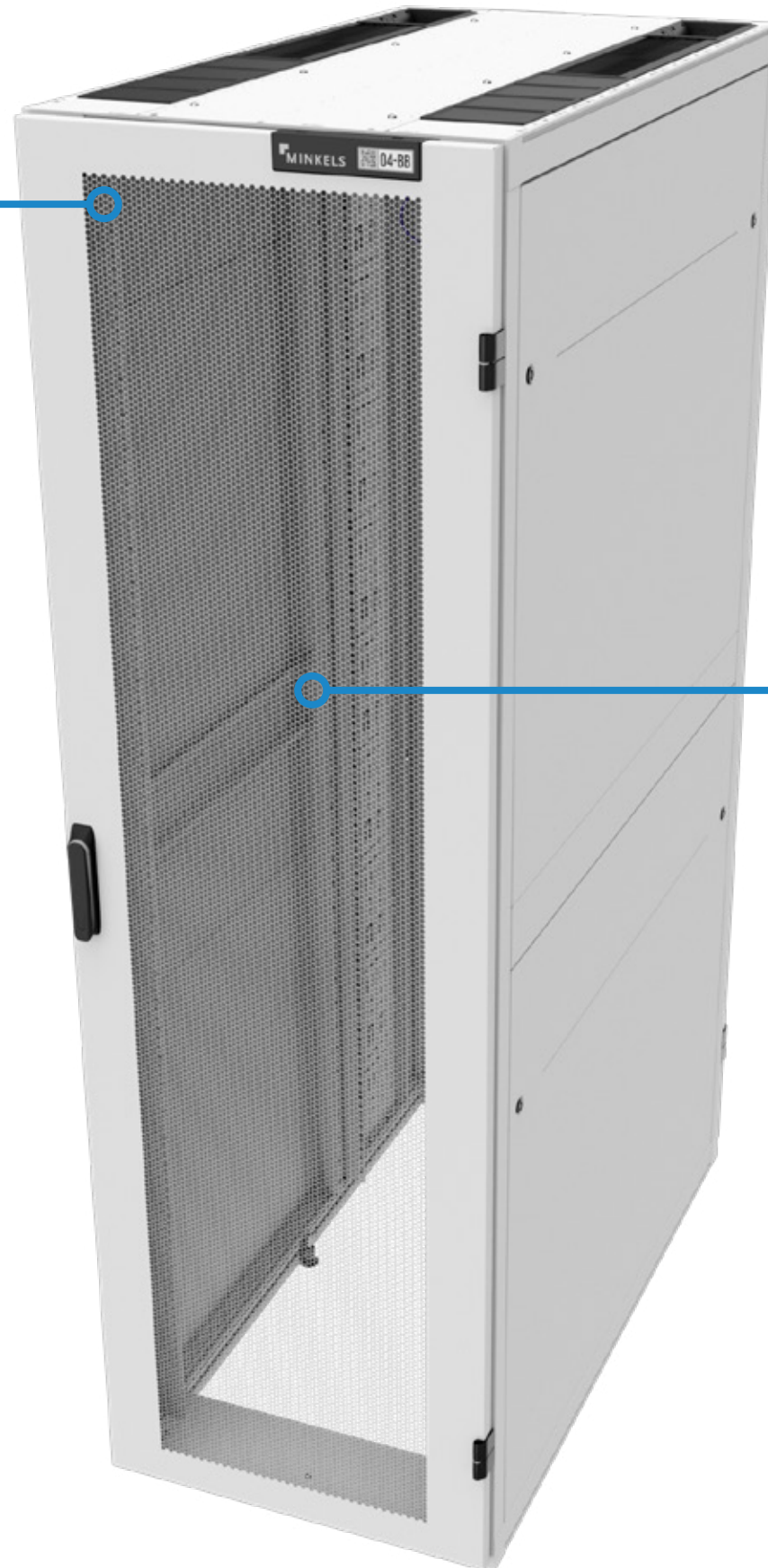

Depth marking placed on depth profiles
Stepless adjustability in depth direction

DOOR

- Predefined position for identification.
 - Place serial numbers, barcodes or QR codes to code and personalize your cabinets.
- Clean and minimalistic design.
- Easy door installation.
- High level perforation
- Full integration of the locking mechanism and cabling (in case of smart lock).
- High level access security.
- Support of different types of locking possible.
- Replacement of locking through detachable cover plate rear.
- Door easily reversible (left/right hinged).
- Door can open 165° in case of bayed cabinets.
- Door can open 260° in case of stand-alone cabinets.

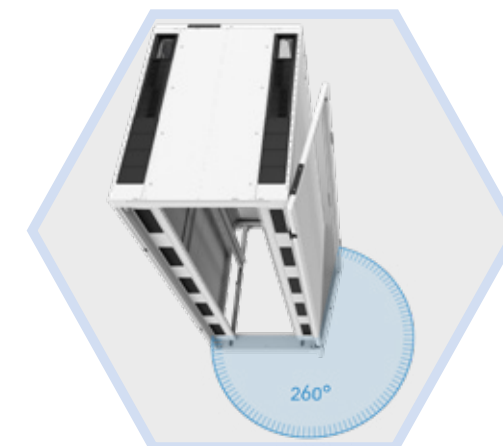

NEXPAND FEATURES

TOP-OF-CABINET

EASY MAINTENANCE

These days, cabling and power distribution is organized on top of the network or server cabinet. By placing this in a more accessible and visible location, the accessibility of the cabling and power supply increases. In this way, it's easier to maintain and make changes to cabling and power distribution than it would be if the cabling was, for example, located under the cabinet.

FLEXIBLE ROOF LAY-OUT

The roof lay-out has been improved considerably – for example, with respect to the positioning and the surfaces of the openings located on the top of the cabinet.

The mounting rails are implemented on the top of cabinet. These mounting rails enable flexible adjustability of accessories, brackets and all possible forms of cable management that can be placed around the entire perimeter across the width and depth of the cabinet.

POWER DISTRIBUTION ON TOP-OF-CABINET

In addition to the fibre optic and copper cables, the power distribution can also be placed on top of cabinets. A power distribution unit is usually placed on the back of the cabinet to connect all the IT equipment to the mains. Top-of-cabinet enables power distribution through cabling and busbars.

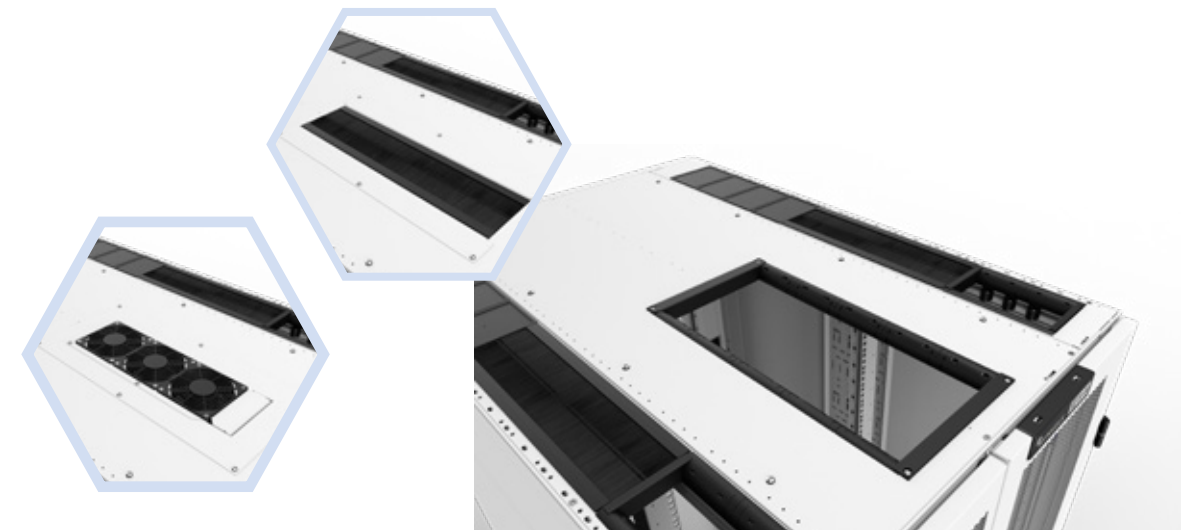

EXTRA CUT-OUT IN THE MIDDLE FOR (HIGH-VOLUME) CABLE MANAGEMENT, BRUSHES OR FAN-UNIT

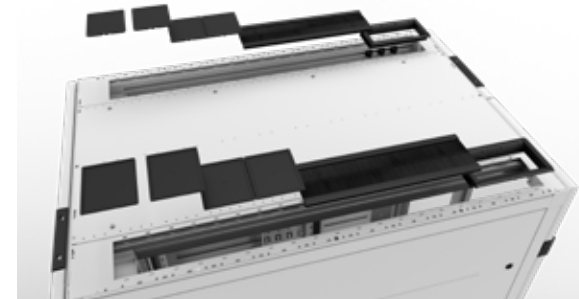
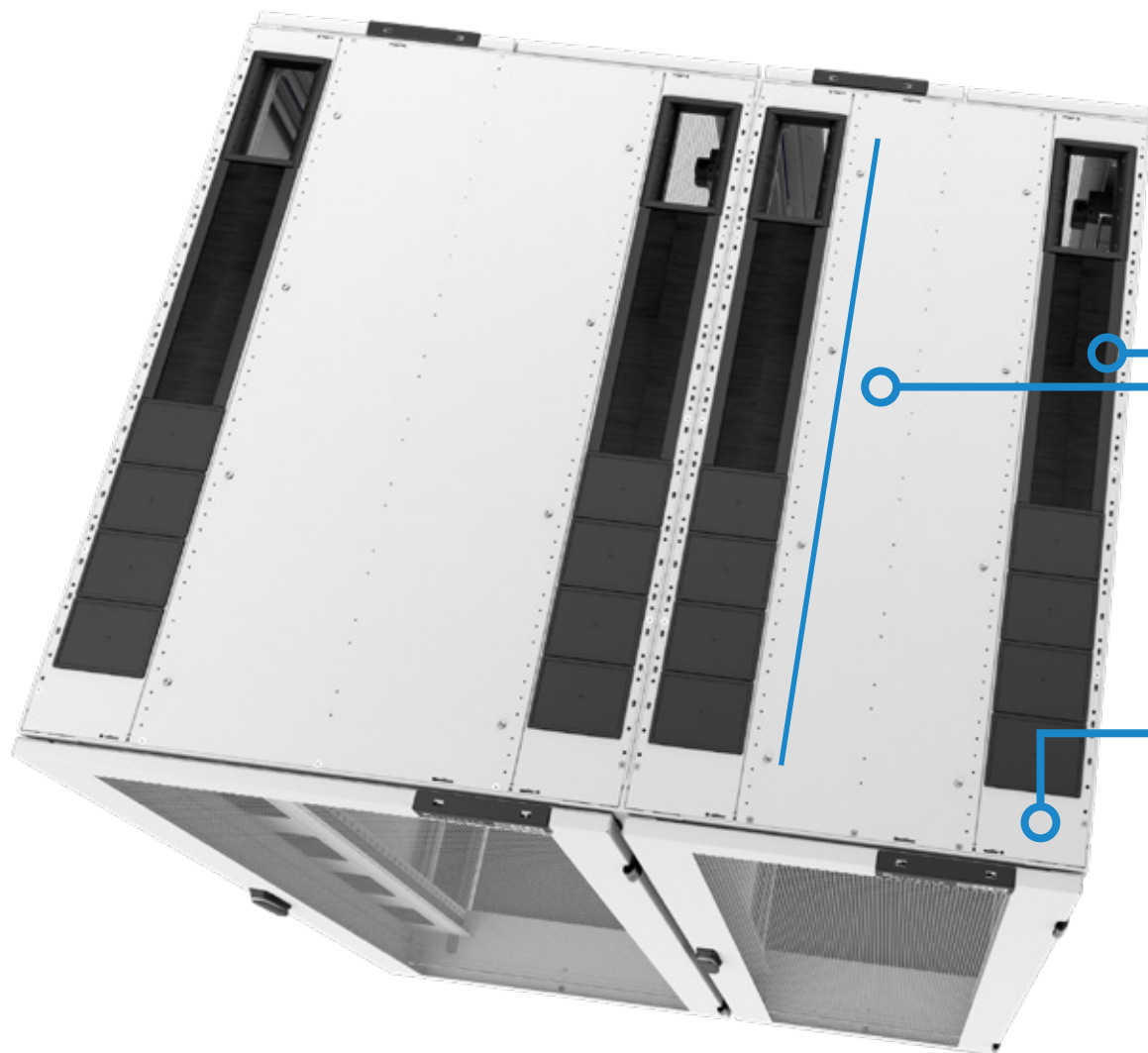

ROOF

- Solid platform for installation top of cabinet infrastructure.
- Roof inserts follow a multiple of 100 mm.
- Nearly full-depth cut-out.
- Optimal accessibility for cabling.
- Optimal positioning for PDU's.
 - Up to 32A plugs shall fit.
- Cable pull relief available.
- Cable dividers on top of cabinet follow the same modularity as the inserts.
 - Extendable per cabinet to create a cable duct system.
 - Cover plates and end covers available for dust/debris protection and airtight solutions.
 - Powder coated in same color as cabinet.
- Roof is compliant with hot/cold aisle containment.

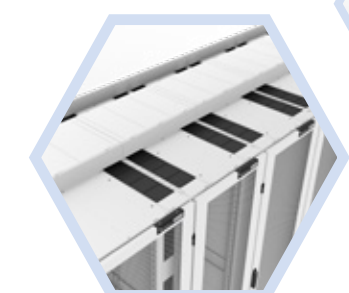
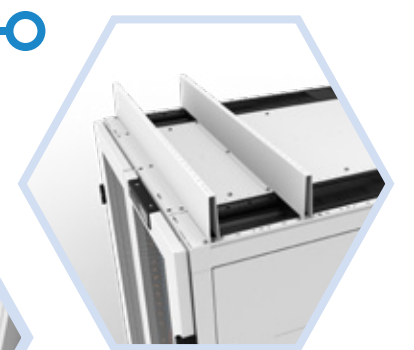
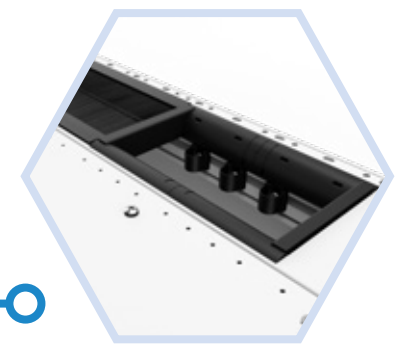

NEXPAND FEATURES

ACCESSORIES

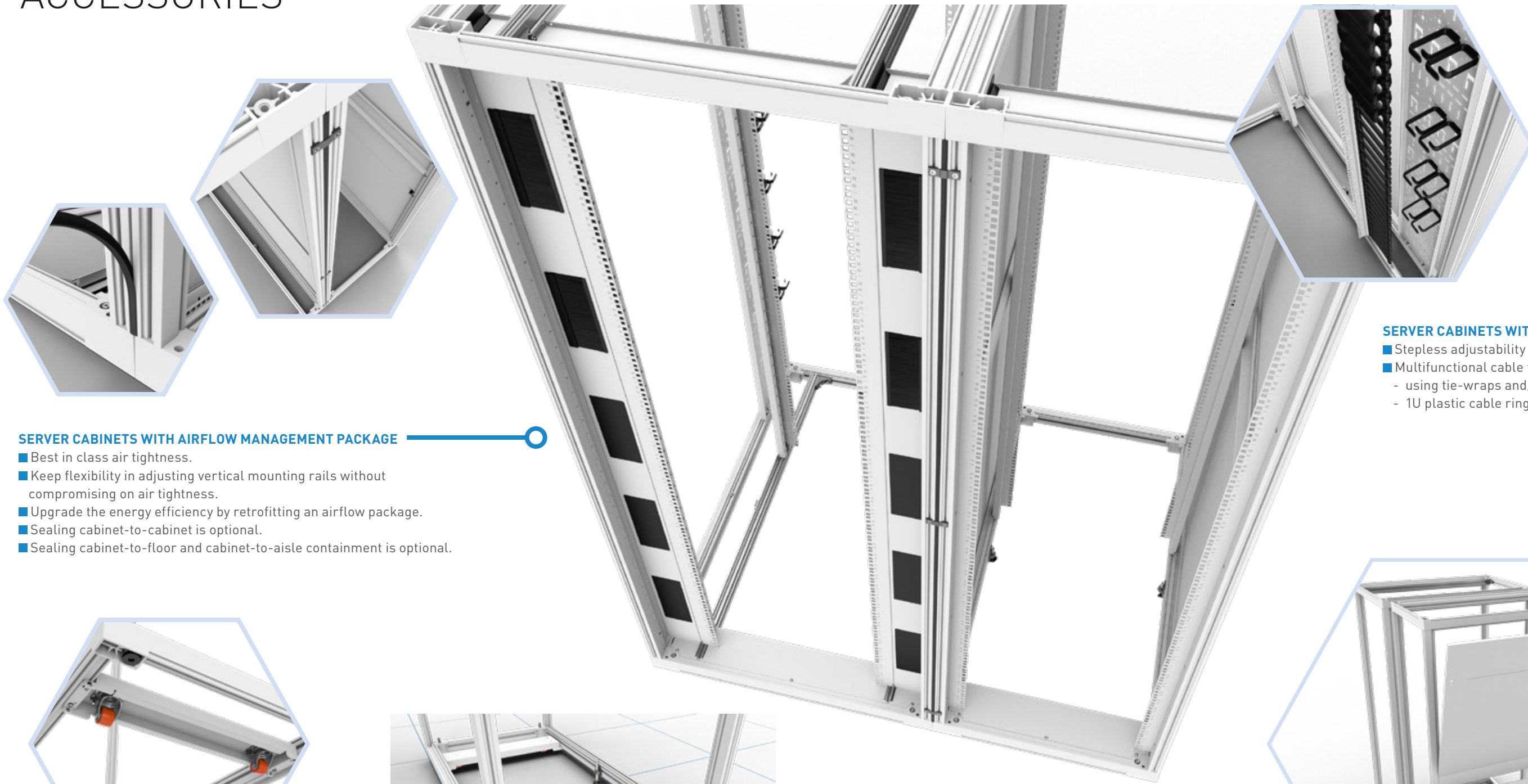

SERVER CABINETS WITH AIRFLOW MANAGEMENT PACKAGE

- Best in class air tightness.
- Keep flexibility in adjusting vertical mounting rails without compromising on air tightness.
- Upgrade the energy efficiency by retrofitting an airflow package.
- Sealing cabinet-to-cabinet is optional.
- Sealing cabinet-to-floor and cabinet-to-aisle containment is optional.

SERVER CABINETS WITH CABLE TRAY

- Stepless adjustability in depth direction.
- Multifunctional cable tray to organise your cabling:
 - using tie-wraps and/or Velcro
 - 1U plastic cable ring, toolless mount

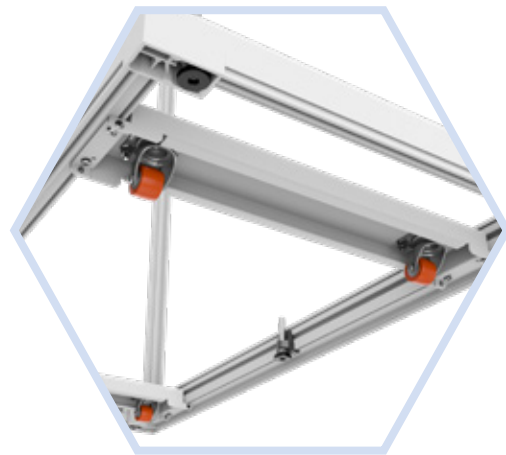

Transport castors available

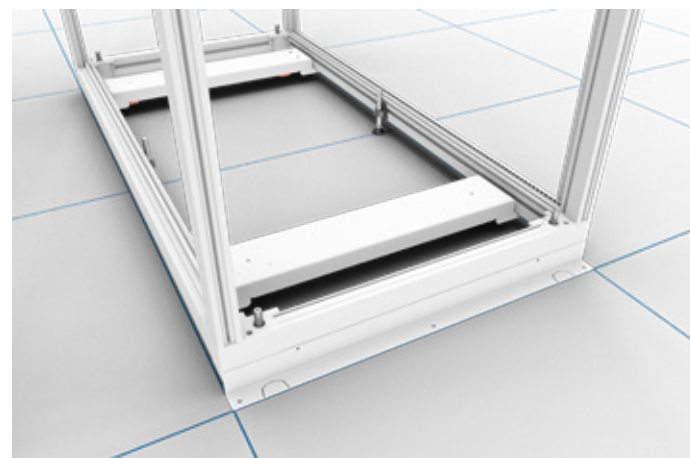

Easy floor tile alignment due to reversible plinth

SERVER CABINETS WITH SIDE PANEL

- Side panels are used when stand-alone is preferred or when the cabinet is placed at the end of the row
- Earthing connection is established when locking the panels
- Horizontally divided panels for easy handling

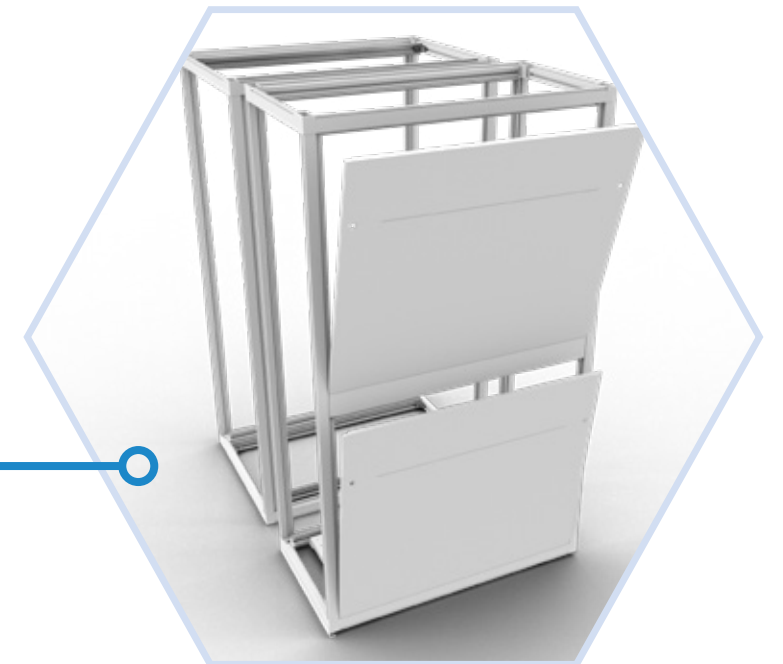



FOLLOW US ON

-  minkels.com
-  youtube.com/c/minkelshq
-  twitter.com/minkels_hq
-  facebook.com/minkels
-  linkedin.com/company/minkels



MINKELS HEADQUARTERS & INTERNATIONAL

Eisenhowerweg 12
P.O. Box 28
5460 AA Veghel
t. +31 (0)413 311 100
info@minkels.com